

ZRC-100
(Z-Wave Remote Controller)



Table of Contents

Introduction	4
Glossary	5
ZRC-100 Operations	6
<i>Product Overview</i>	7
<i>Description of Function Keys</i>	7
<i>ZRC-100 User Interface Layout</i>	8
<i>Operations</i>	10
<i>Add/Delete Devices</i>	11
<i>Device Control</i>	14
<i>Scene Setup</i>	15
<i>Scene Control</i>	18
<i>Comfort Control</i>	19
<i>Sensor Information</i>	20
<i>Device Configure</i>	20
<i>Scene Configure</i>	23
<i>Comfort / Sensor Configure</i>	25
<i>Shortcut Key</i>	27
Z-Wave Advanced Setup	29
<i>Learning Mode</i>	29
<i>Configure Association</i>	31
<i>Change Device Configuration</i>	37
<i>Resetting Your Network</i>	39
<i>System Settings</i>	40
<i>About ZRC-100</i>	42
Z-Wave Network Setup	43
<i>Rediscover Network</i>	43
<i>Re-scan (Rediscover) Devices from network</i>	44
<i>Delete Dead Node from Network</i>	46
<i>Listening Mode</i>	47
<i>Create a Secondary Controller</i>	48
<i>Create a Primary Controller</i>	49
WIRELESS INFORMATION	51
MAINTENANCE	51
FREQUENTLY ASKED QUESTIONS	51
<i>Z-Wave Frequently Asked Questions</i>	51

TECHNICAL SPECIFICATIONS	56
CHECKING THE ACCESSORIES	57
FCC NOTICE	57
WARNINGS	57
CAUTION	58

ZRC-100

(Z-Wave Remote Controller)

Operating Instructions

Introduction

The *ZRC-100* (Figure 1) is a portable Z-Wave remote controller with multi-channel support; also it is a Z-Wave Enabled Security Controller. It can control the secured door locks when it is in the security network. Also, it can be configured as a primary or secondary controller within a Z-Wave home automation network. It works with almost every Z-Wave enabled devices, binary switches, dimmers, thermostats, secured door locks, binary or multi-level sensors. Users can control their Z-Wave enabled devices individually or through “Scene” control. Scene is a collection of Z-Wave devices configured to a user-preferred settings, levels, modes or operating conditions. The ZRC-100 also equipped with a backlit LCD screen and an intelligent Self Navigated Button (SNB) system. Users can setup and operate their Z-Wave devices through the LCD and the SNB system using their ZRC-100, and enjoy a networked, wireless home automation system anywhere at home.

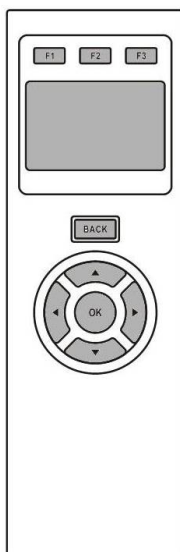

Figure 1 ZRC-100

Glossary

Device or Node	Devices and nodes are all terms to describe an individual Z-Wave device. These are all interchangeable when setting up your Z-Wave network.
Inclusion	Add a Z-Wave device to the network.
Exclusion	Delete a Z-Wave device from the network.
Remove	To take a device out of a group, scene or association group while that device still exists in the same Z-Wave network.
Z-Wave Network	A collection of Z-Wave devices controlled by primary and secondary controllers operating on the same system. A Z-Wave network has its own unique ID code so that controllers not in the network cannot control the system.
Primary Controller	The first controller used to set up your devices and network. Only the Primary Controller can be used to include or delete modules from a network. It is recommended that you mark the primary controller for each network for ease in modifying your network.
Secondary Controller	A controller containing network information about other modules within the network and is used for controlling devices. Secondary controller is created from the Primary Controller and cannot include or delete modules to the network.
Inclusion Controller	A controller containing network information about other modules within the network and is used for controlling devices. Inclusion controller is created from the Primary Controller in a SIS enabled Z-Wave network. Inclusion Controller has the ability to add and remove devices from the network.
Scene	A collection of Z-Wave devices configured to turn to a specific level, setting, mode, or perform an operation. Scenes are usually activated by a controller, timed event, or specific conditions.

ZRC-100 Operations

Welcome to the world of Z-Wave home automation, you can use your ZRC-100 to control almost every Z-Wave certified products inside your house. The following section will guide you through the set up processes and operation procedures for your ZRC-100.

Please note that all Z-Wave devices, light switches, dimmers, shutter switches, thermostat and secured door lock made from various vendors are compatible with your ZRC-100 as long as they are Z-Wave certified or carry the following Z-Wave logo:



(Please carefully read through the following sections of this user manual and store for future reference.)

Before using the ZRC-100, please install the batteries:

- 4xAAA batteries are required for operation.
- Remove the battery cover on the back of your remote.
- Check the polarity of the batteries and the "+/-" marks inside the battery compartment.
- Insert the batteries.
- Push the battery cover back in place.

ⓘ CAUTION (battery safety)

- Use new batteries of the recommended type and size only.
- Never mix used and new batteries together.
- To avoid chemical leaks, remove batteries from the remote controller if you do not intend to use the remote for an extended period of time.
- Dispose of used batteries properly; do not burn or bury them.

Product Overview

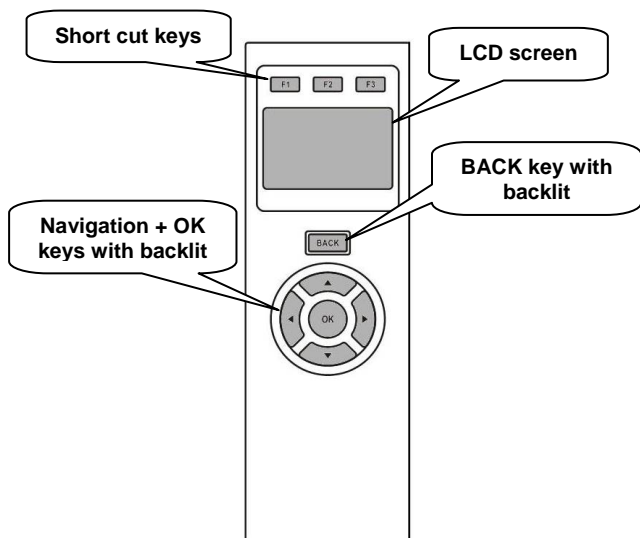









Figure 2 Setup and control keys of ZRC-100



Description of Function Keys

Keys	Functions
  	Short cut keys for: 1. Device and scene control 2. Short cut to user selected control menu
	Back to previous screen
	4-way directional keys for setup and control OK key for confirmation

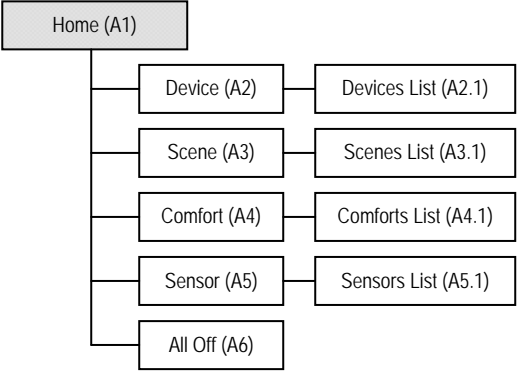

ZRC-100 User Interface Layout

Control menu	 or 	<ul style="list-style-type: none">• Press ▲ or ▼ keys to select control category.• Press BACK key to go back to previous page.• Press and hold BACK key for 2 seconds to go back to root menu.
--------------	--	--

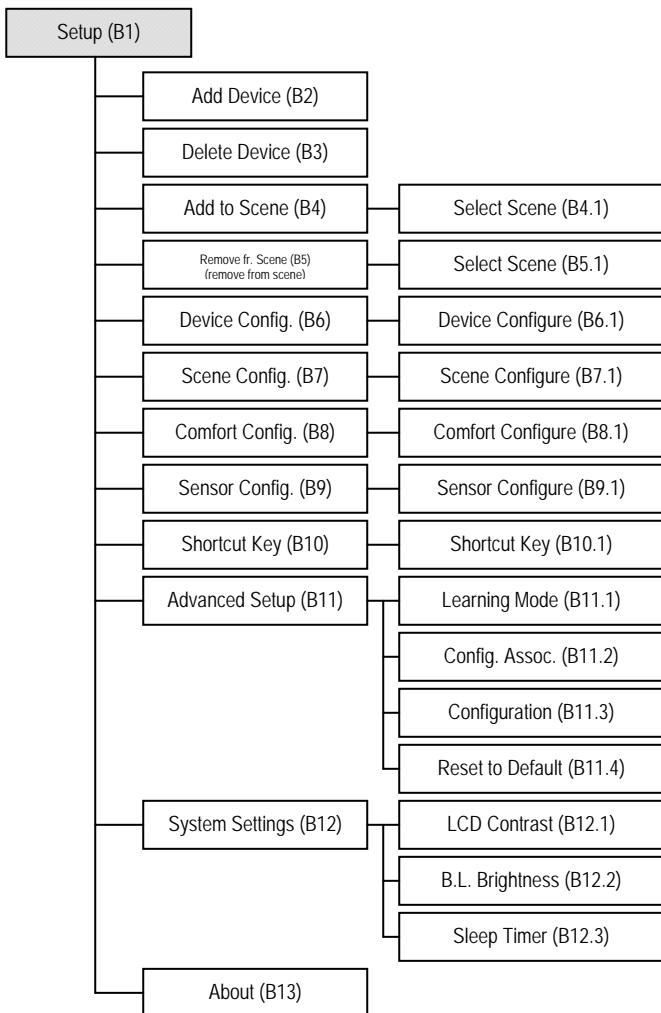

Setup menu	 + 	<ul style="list-style-type: none"> • Press and hold ◀ ▶ keys simultaneously for 3 seconds to enter Setup menu. • Press BACK key to go back to previous page. • Press and hold BACK key for 2 seconds to go back to root menu.
------------	---	--



Network Setup menu	 + 	<ul style="list-style-type: none"> • Press and hold ▲▼ keys simultaneously for 3 seconds to enter Network Setup menu. • Press BACK key to go back to previous page. • Press and hold BACK key for 2 seconds to go back to root menu.
--------------------	---	---

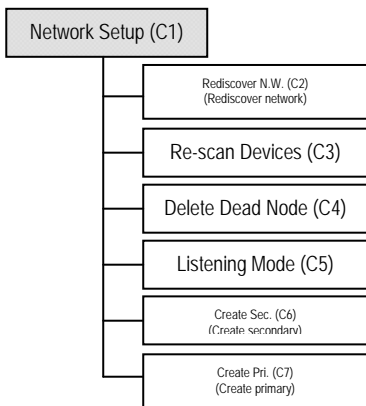



Operations

The ZRC-100 remote controller can be set up as a Primary or Secondary Controller within a Z-Wave network.

The ZRC-100 can control Z-Wave devices individually or as a group using Scene or Association. A single Z-Wave network can include 232 nodes. If necessary, more than one network can be bridged to extend the number of nodes supported, although this is normally not needed in a residential environment.



ZRC-100 control capability	
Total number of controllable End-point (EP) / device / sensor	128 items (listed on the “Device” and “Sensor” page)
Total number of thermostats	6 thermostats (listed on the “Comfort” page)
Total number of scenes	12 scenes (listed on the “Scene” page)
Each Scene supports up to	32 Z-Wave devices or End-point (EP)

Remark:

- The hard keys are valid if the backlit is turned on and vice versa. User can follow the Self Navigated Button (SNB) and LCD display for all setup procedures and operation.
- User can press “” key to go back to the previous page or press and hold “” key for 2 seconds to go back to the root menu at any setup /operation screen.

Add/Delete Devices

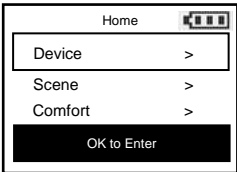
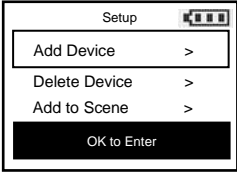
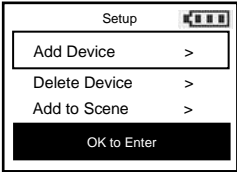
Adding Device to the Network

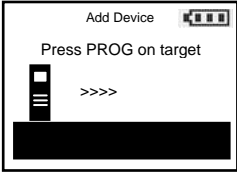
Step	Setup Key	LCD Indication
1	Press and hold ◀ ▶ keys simultaneously for 3 seconds under the Home page.	 ↓ 
2	Select “Add Device” .	
3	Press  key to add the device into Z-Wave network.	

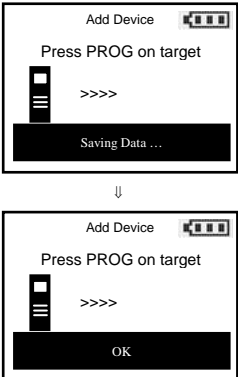
4	Press the program button on the target device.	
---	--	---

Note 1: If you can't add your Z-Wave device, this device might have been included in another Z-Wave network. In this case, please delete this device following the steps in the [Deleting Device from the Network] section then add this device again.









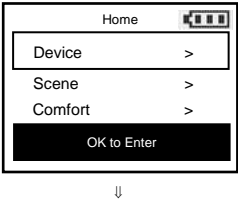

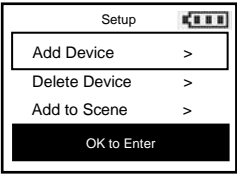

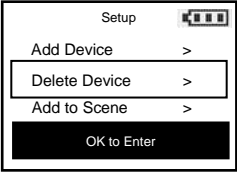

Note 2: This step can be skipped if the device is already included in the network.

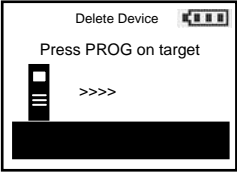
Note 3: In a Z-Wave network, only the primary controller or inclusion controller can add or include devices into its network. If ZRC-100 is configured as a secondary controller, it will report "Error" if users attempt to use ZRC-100 to add a device into its network.

Note 4: If no ACK signal received for more than 60 seconds, the "Add Device" mode will exit automatically.

Deleting Device from the Network

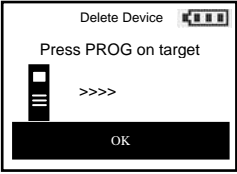
Step	Setup Key	LCD Indication
1	Press and hold ◀ ▶ keys simultaneously for 3 seconds under the Home page.	





		 <p>Setup </p> <p>Add Device ></p> <p>Delete Device ></p> <p>Add to Scene ></p> <p>OK to Enter</p>
2	Select "Delete Device" .	 <p>Setup </p> <p>Add Device ></p> <p>Delete Device ></p> <p>Add to Scene ></p> <p>OK to Enter</p>
3	 Press  key to delete the device from Z-Wave network.	 <p>Delete Device </p> <p>Press PROG on target</p> <p> >>>></p>
4	Press the program button on the target device.	 <p>Delete Device </p> <p>Press PROG on target</p> <p> >>>></p> <p>Saving Data ...</p> <p>↓</p>  <p>Delete Device </p> <p>Press PROG on target</p> <p> >>>></p> <p>OK</p>

Note 1: If no ACK signal received for more than 60 seconds, the "Delete Device" mode will exit automatically.

Note 2: In a Z-Wave network, only the primary controller or inclusion controller can delete or exclude devices into its network. If ZRC-100 is configured as a secondary controller, it will report "Error" if users attempt to use ZRC-100 to delete a device from its network.

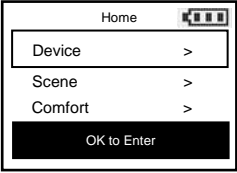
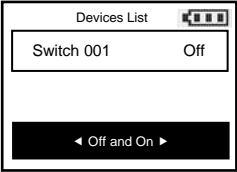
Device Control

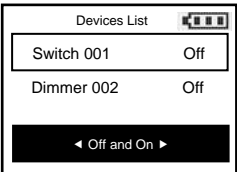
After adding devices to your ZRC-100, you can turn the device using the corresponding Device Control function.

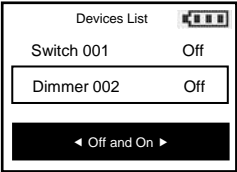
Step	Setup Key	LCD Indication
1	Select "Device" and press  key to confirm. A corresponding Device control page will be displayed.	 <p style="text-align: center;">⇓</p> 
2	For on/off switches, press  key to turn on the device and  key to turn off the device.	
3	To operate dimmer and motorized curtain: Press and hold the  key until reach to your desired level and release the key to open the curtain or to increase the dimmer intensity. Press and hold the  key until reach to your desired level and release the key to retract the curtain or to reduce the dimmer intensity.	

4	<p>You can turn off all the devices in the network by selecting “All Off” function under the Home page.</p>	
---	---	--

Note 1: The screen will display LOCK /UNLK if this is a secured door lock device.

Note 2: You can rename your device, please refer to user manual [step of B6 - Device Config.].



Scene Setup

Scene is a collection of Z-Wave devices configured to user specified levels, settings, modes, or operating conditions. Scenes are usually activated by a controller, timed event, or specific conditions. For example, a user prefers to set the dimmer to a low intensity level and close the motorized curtain when he watch movie. He can define a scene to control the dimmer and motorized curtain using a single scene command.

You can control up to 12 scenes (Scene On/Off) with your ZRC-100. Each Scene supports up to 32 Z-Wave devices or End-Point (EP).

Adding Device/End-point to a Scene





Step	Setup Key	LCD Indication
1	<p>Press and hold ◀ ▶ keys simultaneously for 3 seconds under the Home page.</p>	

2	Select "Add to Scene" and press  key.	
3	Select a Scene which you want to add the device into Scene and press  key.	
4	Press the program button on the target device.	
5	Adjust the target device on/off or dim level with its program button, to the desired level.	

Note 1: Your target device must be included in the network before this setup procedure, please refer to [Adding Device to the Network] section.

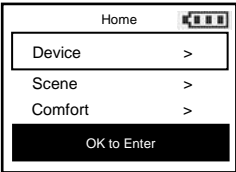
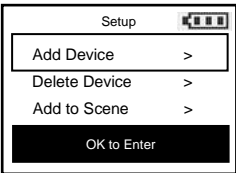
Note 2: If no ACK signal received for more than 60 seconds, the “Add Device” mode will exit automatically.

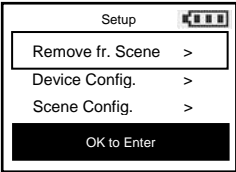
Removing Device/End-point from a Scene

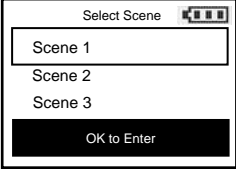
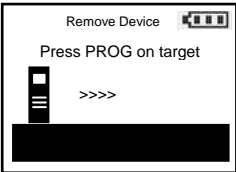
Step	Setup Key	LCD Indication
1	Press and hold ◀ ▶ keys simultaneously for 3 seconds under the Home page.	 <p style="text-align: center;">⇓</p> 
2	Select “Remove from Scene” and press  key.	
3	Select a Scene which you want to delete the device from Scene and press  key.	
4	Press the program button on the target device.	 <p style="text-align: center;">⇓</p>

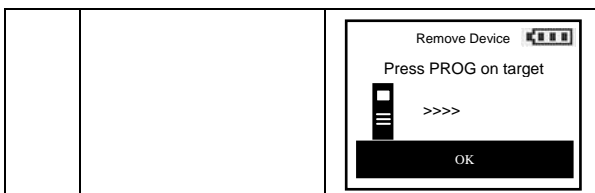



Note 1: This process will only remove the target device/EP from its assigned scene but will not exclude it from the network.

Note 2: If no ACK signal received for more than 60 seconds, the “Remove Device” mode will exit automatically.



Scene Control

After the scene setup is done, you can trigger the desired scene via scene control function on ZRC-100.

Step	Setup Key	LCD Indication
1	Select “Scene” and press  key to confirm. A corresponding Scene Control page will be displayed.	
2	Select your Scene and press  key to turn on the Scene and  key to turn off the Scene.	

Comfort Control

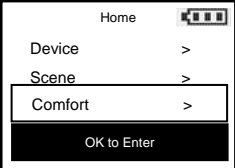
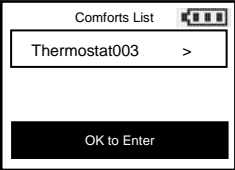
After adding “Thermostat” or “Z-Wave to AC IR extender” to your ZRC-100, you can change the operation mode, set target temperature and fan speed via the corresponding Comfort Control function.

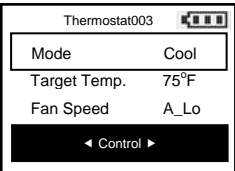
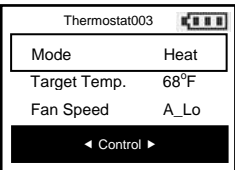
Step	Setup Key	LCD Indication
1	Select “Comfort” and press  key to confirm. A corresponding Comfort Control page will be displayed.	 <p style="text-align: center;">⇓</p> 
2	Select your Thermostat and press  key to enter the Thermostat control page.	
3	Use ◀ ▶ keys to switch the operation mode, set target temperature or fan speed.	

Sensor information



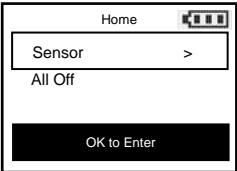
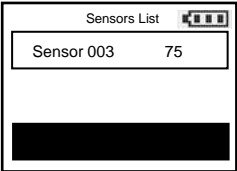





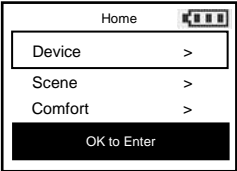
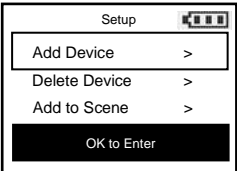

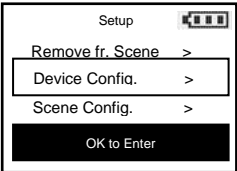

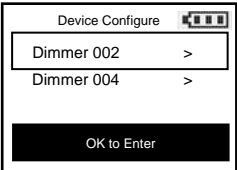
After adding “Binary Sensor / Multi-level Sensor” to your ZRC-100, you can monitor the sensor temperature via the corresponding Sensor function.

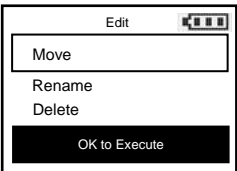

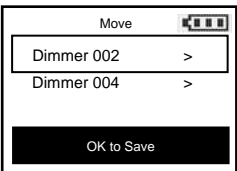
Step	Setup Key	LCD Indication
1	Select “Sensor” and press  key to confirm. A corresponding Sensor page will be displayed.	 ↓ 

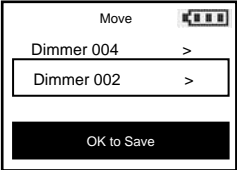
Device Configure

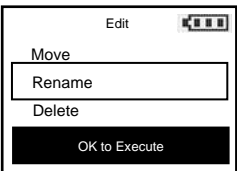
It is allow to Move/Rename/Delete the device after added into the network under the Device Configure function.

Step	Setup Key	LCD Indication
1	Press and hold ◀ ▶ keys simultaneously for 3 seconds under the Home page.	 ↓ 

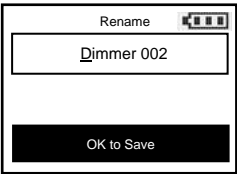
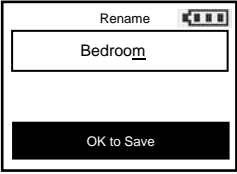
2	<p>Select “Device Configure” and press  key.</p>	 <p>Setup </p> <p>Remove fr. Scene ></p> <p>Device Config. ></p> <p>Scene Config. ></p> <p>OK to Enter</p>
3	<p>Select your “Device” and press  key.</p>	 <p>Device Configure </p> <p>Dimmer 002 ></p> <p>Dimmer 004 ></p> <p>OK to Enter</p>
4	<p>Select your action (e.g. Move) and press  key.</p>	 <p>Edit </p> <p>Move</p> <p>Rename</p> <p>Delete</p> <p>OK to Execute</p>
5	<p>Move your selected device to your target position and press  to save the setting.</p>	 <p>Move </p> <p>Dimmer 002 ></p> <p>Dimmer 004 ></p> <p>OK to Save</p> <p style="text-align: center;">↓</p>  <p>Move </p> <p>Dimmer 004 ></p> <p>Dimmer 002 ></p> <p>OK to Save</p>
6	<p>Select your action (e.g. Rename) and press  key.</p>	 <p>Edit </p> <p>Move</p> <p>Rename</p> <p>Delete</p> <p>OK to Execute</p>

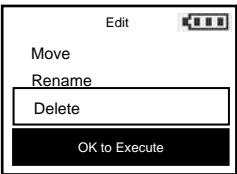
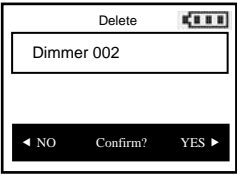





7	<p>Use ▲▼ keys to change your character and ◀▶ keys to select character position, press  to save the setting.</p>	 <p style="text-align: center;">↓</p> 
8	<p>Select your action (e.g. Delete) and press  key.</p>	
9	<p>Press ▶ key to confirm to delete the selected device or Press ◀ key to cancel it and go back to previous page.</p>	



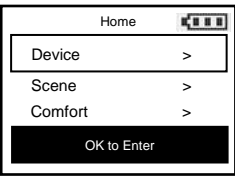
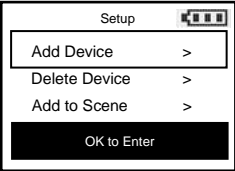

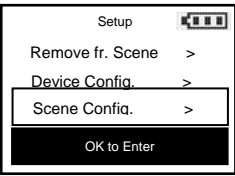

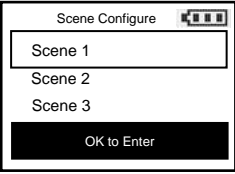

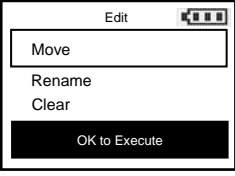

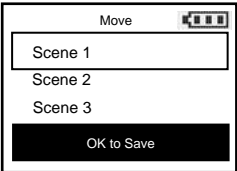

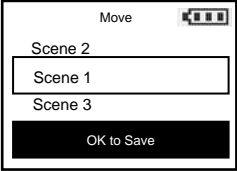
Note 1: ZRC-100 supports up to 16 characters in a row for the device name.

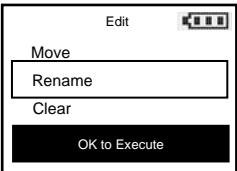
Note 2: This process will only remove the devices/EPs from its catalogue but will not exclude it from the network.

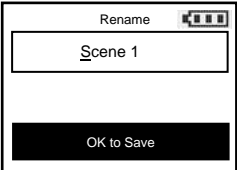
Scene Configure

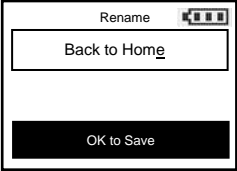
It is allow to Move/Rename/Clear the scene after added into the scene under the Scene Configure function.

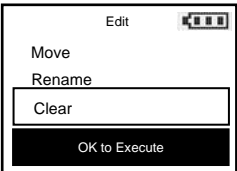
Step	Setup Key	LCD Indication
1	Press and hold ◀ ▶ keys simultaneously for 3 seconds under the Home page.	 <p style="text-align: center;">↓</p> 
2	Select “Scene Configure” and press  key.	
3	Select your “Scene” and press  key.	
4	Select your action (e.g. Move) and press  key.	

5	<p>Move your selected scene to your target position and press  to save the setting.</p>	 <p>Move </p> <p>Scene 1</p> <p>Scene 2</p> <p>Scene 3</p> <p>OK to Save</p> <p>↓</p>  <p>Move </p> <p>Scene 2</p> <p>Scene 1</p> <p>Scene 3</p> <p>OK to Save</p>
6	<p>Select your action (e.g. Rename) and press  key.</p>	 <p>Edit </p> <p>Move</p> <p>Rename</p> <p>Clear</p> <p>OK to Execute</p>
7	<p>Use ▲▼ keys to change your character and ◀▶ keys to select character position, press  to save the setting.</p>	 <p>Rename </p> <p>Scene 1</p> <p>OK to Save</p> <p>↓</p>  <p>Rename </p> <p>Back to Home</p> <p>OK to Save</p>
8	<p>Select your action (e.g. Clear) and press  key.</p>	 <p>Edit </p> <p>Move</p> <p>Rename</p> <p>Clear</p> <p>OK to Execute</p>

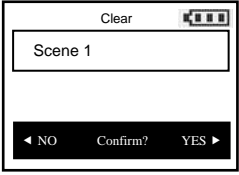
9	<p>Press ► key to confirm to clear the selected scene or</p> <p>Press ◀ key to cancel it and go back to previous page.</p>	
---	--	---



Note 1: ZRC-100 supports up to 16 characters in a row for the scene name.







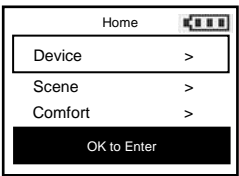
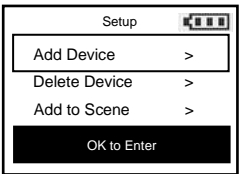

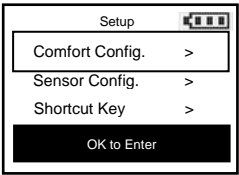
Note 2: This process will only remove the scene devices/EPs from its assigned scene but will not exclude it from the network.

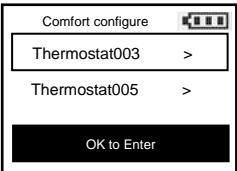

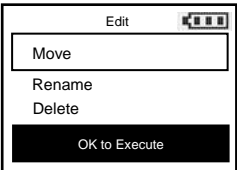
Note 3: The above steps are needed if ZRC-100 to be a secondary remote controller and the Scene information mapping from gateway / primary controller is unsuccessful.

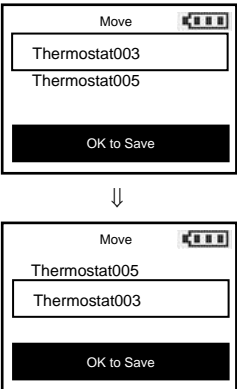
Comfort / Sensor Configure

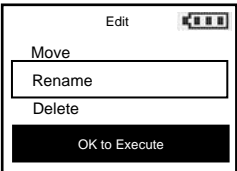
It is allow to Move/Rename/Delete the device after added into the network under the Comfort / Sensor Configure function.

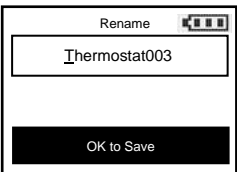
Step	Setup Key	LCD Indication
1	<p>Press and hold ◀ ► keys simultaneously for 3 seconds under the Home page.</p>	 <p style="text-align: center;">↓</p> 
2	<p>Select “Comfort Configure” and press  key.</p>	

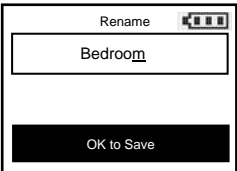
3	<p>Select your “Thermostat” and press  key.</p>	
4	<p>Select your action (e.g. Move) and press  key.</p>	
5	<p>Move your selected Thermostat to your target position and press  to save the setting.</p>	
6	<p>Select your action (e.g. Rename) and press  key.</p>	
7	<p>Use ▲▼ keys to change your character and ◀▶ keys to select character position, press  to save the setting.</p>	

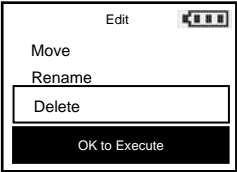
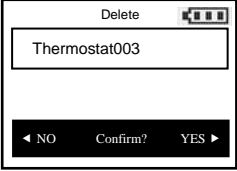
		
8	Select your action (e.g. Delete) and press  key.	
9	Press ► key to confirm to delete the selected thermostat or Press ◀ key to cancel it and go back to previous page.	







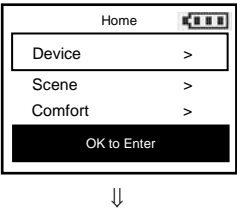

Note 1: ZRC-100 supports up to 16 characters in a row for the scene name.

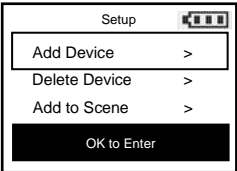
Note 2: This process will only remove the devices/EPs from its catalogue but will not exclude it from the network.

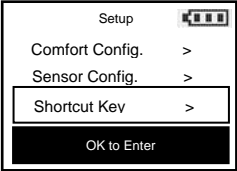
Shortcut key

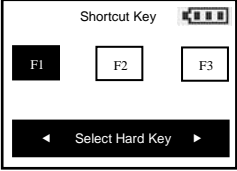
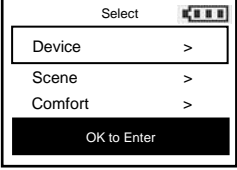
ZRC-100 provides a shortcut key which can jump to your target Comfort / Sensor device or turn On/Off your device/ Scene.

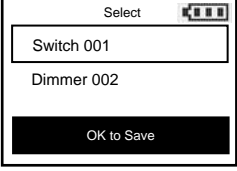
Step	Setup Key	LCD Indication
1	Press and hold ◀ ► keys simultaneously for 3 seconds under the Home page.	

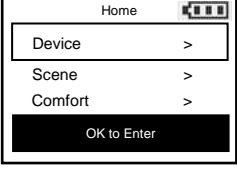
		
2	Select "Shortcut key" and press  key.	
3	Select your target shortcut key by ◀▶ keys (e.g. F1) then press  key.	
4	Select your target Device / Scene / All Off for your shortcut key or Select your target shortcut page (Comfort / Sensor) for your shortcut key.	
5	Select a Device or Scene to this shortcut key then press  key.	
6	Press  key to turn On your Device or Scene at any page or Press and hold  key to turn Off your Device or Scene at any page. <i>(Press your shortcut key can jump to your target Comfort / Sensor device)</i>	







Z-Wave Advanced Setup

Learning Mode

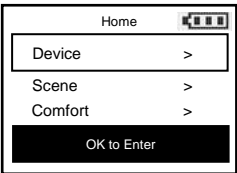
(Replicating All Network and Device Information from a Primary Controller to your ZRC-100)

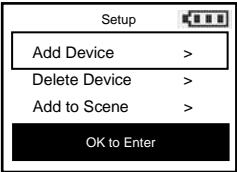
Your ZRC-100 can:

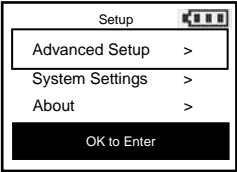
- Copy the settings from another Z-Wave controller.
- Be included into existing Z-Wave network and act as a secondary remote controller or back to a new primary remote controller.
- Be excluded from the Z-Wave network.

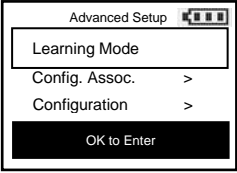
Step	Setup Key	LCD Indication
1	Place the two controllers close to each other.	-
2	Press and hold ◀ ▶ keys simultaneously for 3 seconds under the Home page.	  
3	Select “Advanced Setup” and press  key.	
4	Select “Learning Mode” and press  key. Please make sure the primary controller is setup to send information. (Refer to	

	the primary controller user manual for more information)	
5	<p>Place the two controllers close to each other.</p> <p>(LCD display <u>OK</u> if the learning mode is successful.</p> <p>LCD display <u>ERROR</u> if the learning mode is unsuccessful.)</p>	

ⓘ CAUTION

Scene Controller Configuration Command and Association Command

If scenes are copied to a secondary controller using the replication function, those scenes cannot be modified using the Scene Controller Configuration and Association Commands. If modifications are desired, it is recommended to delete all these scenes from the controller prior to using the two aforementioned commands.







Configure Association

(Assign Association for Two Devices)

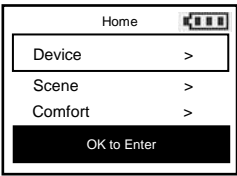
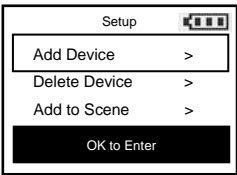
The ZRC-100 can be used to assign one device to automatically interact directly with another device.

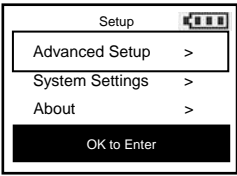
For example you can assign a door sensor (primary node) to turn on the light switch (secondary node) when the door is opened.

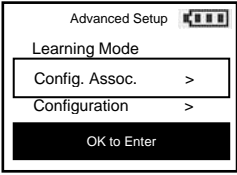

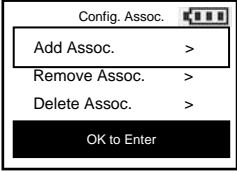

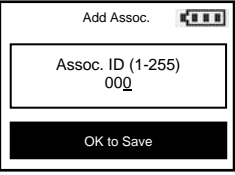
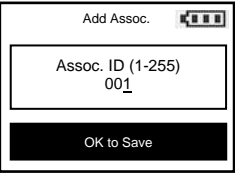
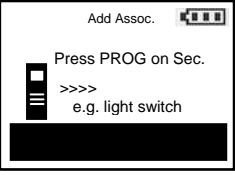
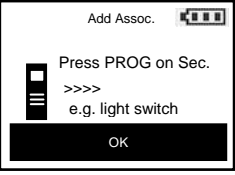
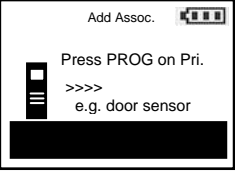
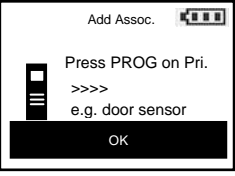

Adding Device/End-point to an Association Group

Step	Setup Key	LCD Indication
1	Press and hold ◀ ▶ keys simultaneously for 3 seconds under the Home page.	 ↓ 
2	Select "Advanced Setup" and press  key.	
3	Select "Config. Assoc." and press  key.	
4	Select "Add Assoc." and press  key.	

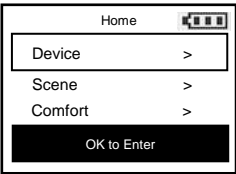
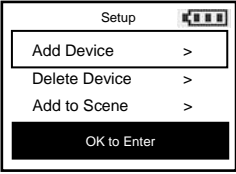
<p>5</p>	<p>Assign an “Assoc. ID” (e.g. 001) by using ▲▼keys to change your number and ◀▶ keys to select number position.</p> <p>Press  key to save the settings.</p>	 <p style="text-align: center;">↓</p> 
<p>6</p>	<p>Press the program/EP button on the secondary device (e.g. light switch)</p>	 <p style="text-align: center;">↓</p> 
<p>7</p>	<p>Press the program/EP button on the primary device (e.g. door sensor)</p> <p><i>=> It will turn on the light switch when the door is open.</i></p>	 <p style="text-align: center;">↓</p> 

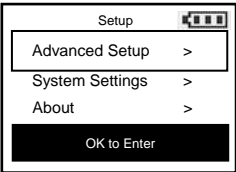
Note 1: Your target device must be included in the network before this setup procedure, please refer to [Adding Device to the Network] section.

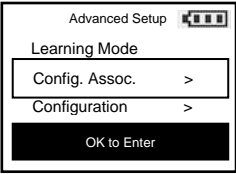

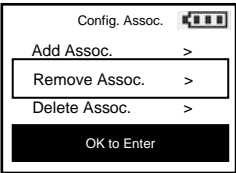

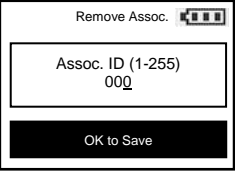
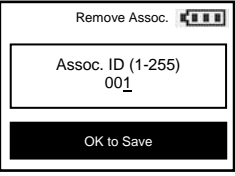
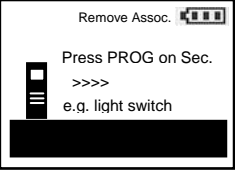
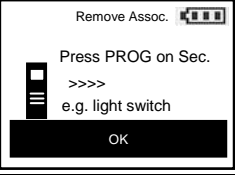
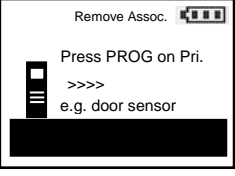
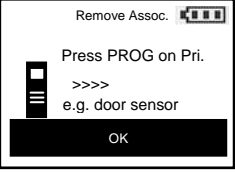

Removing Device/End-point from an Association Group

Step	Setup Key	LCD Indication
1	Press and hold ◀ ▶ keys simultaneously for 3 seconds under the Home page.	 <p style="text-align: center;">↓</p> 
2	Select “Advanced Setup” and press  key.	
3	Select “Config. Assoc.” and press  key.	
4	Select “Remove Assoc.” and press  key.	

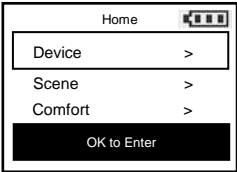
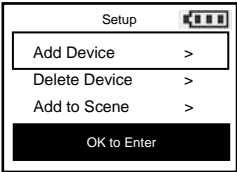
5	<p>Select an "Assoc. ID" (e.g. 001) by using ▲▼ keys to change your number and ◀▶ keys to select number position.</p> <p>Press  key to save the settings.</p>	 <p style="text-align: center;">⇓</p> 
6	<p>Press the program/EP button on the secondary device (e.g. light switch)</p>	 <p style="text-align: center;">⇓</p> 
7	<p>Press the program/EP button on the primary device (e.g. door sensor)</p>	 <p style="text-align: center;">⇓</p> 

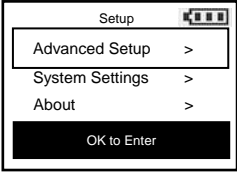
Note 1: This process will only remove the target device/EP from its assigned association group but will not exclude it from the network.

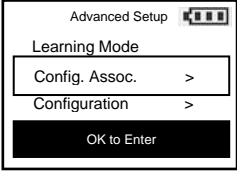
Deleting an Association Group

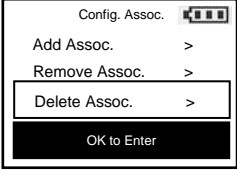
Step	Setup Key	LCD Indication
1	Press and hold ◀ ▶ keys simultaneously for 3 seconds under the Home page.	 <p style="text-align: center;">↓</p> 
2	Select “Advanced Setup” and press  key.	
3	Select “Config. Assoc.” and press  key.	
4	Select “Delete Assoc.” and press  key.	

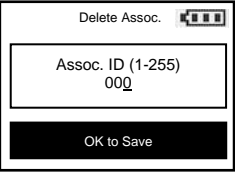
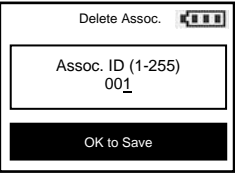
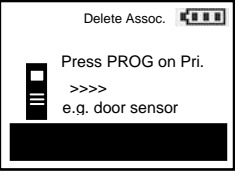
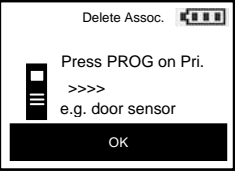





5	<p>Select an “Assoc. ID” (e.g. 001) by using ▲▼ keys to change your number and ◀▶ keys to select number position.</p> <p>Press  key to save the settings.</p>	 <p style="text-align: center;">↓</p> 
6	<p>Press the program/EP button on the primary device (e.g. door sensor)</p>	 <p style="text-align: center;">↓</p> 

Note 1: This process will only remove the group devices/EPs from its assigned association group but will not exclude it from the network.

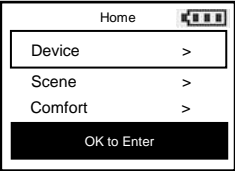
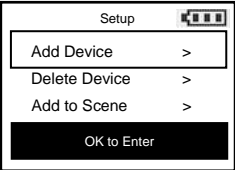
Change Device Configuration

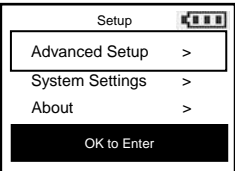
This function is used to modify the parameter of the Z-Wave device via the configuration command class.

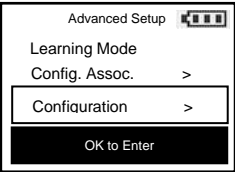

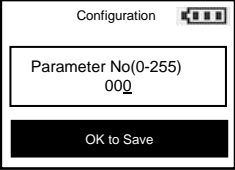

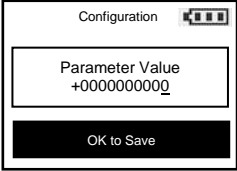
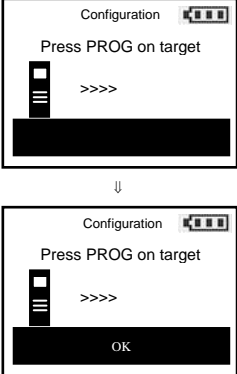
Look up the Parameter No. and Parameter Value of the target device from the device user manual before you start the below process.

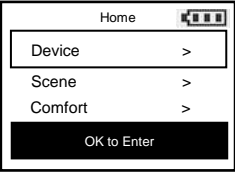
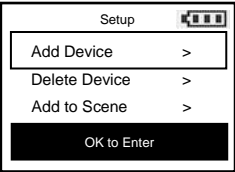

Step	Setup Key	LCD Indication
1	Press and hold ◀ ▶ keys simultaneously for 3 seconds under the Home page.	 <p style="text-align: center;">↓</p> 
2	Select “Advanced Setup” and press  key.	
3	Select “Configuration” and press  key.	
4	Use ▲ ▼ keys to change your parameter number and ◀ ▶ keys to select number position, press  to save the setting.	

<p>5</p>	<p>Use ▲▼ keys to change your parameter value and ◀▶ keys to select number position, press  to save the setting.</p> <p>(Parameter value from -2147483648 to +2147483647 (32bits value))</p>	
<p>6</p>	<p>Press the program button on the target device.</p>	

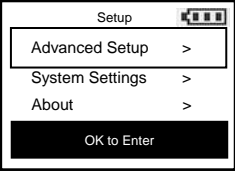
Resetting Your Network

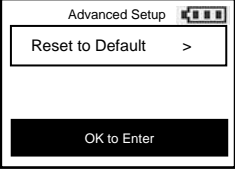
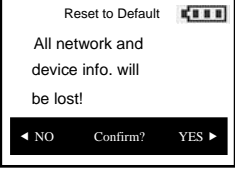

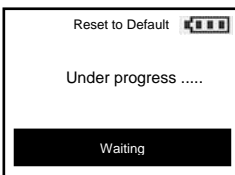
You can reset your ZRC-100 to clear all Z-Wave network and device information by the following steps:



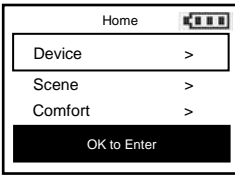
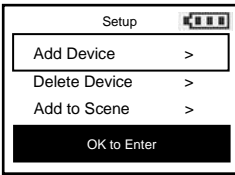

Step	Setup Key	LCD Indication
1	Press and hold ◀ ▶ keys simultaneously for 3 seconds under the Home page.	 <p style="text-align: center;">⇓</p> 
2	Select “Advanced Setup” and press  key.	
3	Select “Reset to Default” and press  key.	
4	Press ▶ key to confirm to reset to factory default or Press ◀ key to cancel it and go back to previous page.	 <p style="text-align: center;">⇓</p>

		 <p style="text-align: center;">↓</p> 
--	--	--

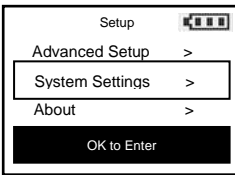
Note: After reset the remote, each device should individually perform in the section on “Delete device from the network” and “Add device to the network”.

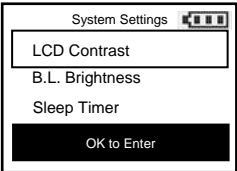
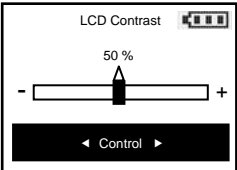

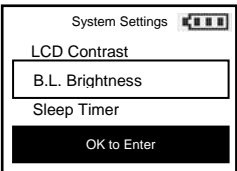
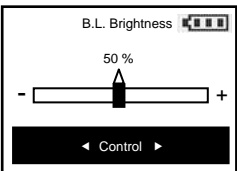
System Settings

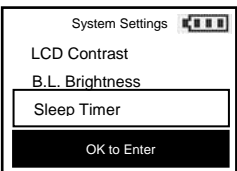
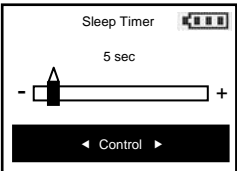
Step	Setup Key	LCD Indication
1	Press and hold ◀ ▶ keys simultaneously for 3 seconds under the Home page.	 <p style="text-align: center;">↓</p> 
2	Select “System Settings” and press  key.	

3	Select "LCD Contrast" and press  key.	
4	Press ◀ ▶ keys to adjust the LCD contrast.	
5	Press  key to save and return to previous page then select "B.L. Brightness" and press  key.	
6	Press ◀ ▶ keys to adjust the backlight brightness.	
7	Press  key to save and return to previous page then select "Sleep Timer" and press  key.	
8	Press ◀ ▶ keys to adjust the sleep timer.	

Note 1: The batteries service life will be shortened if the sleep timer set to higher value.

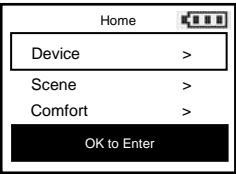
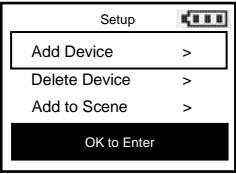

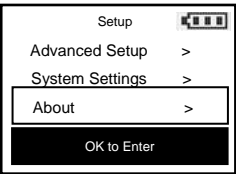
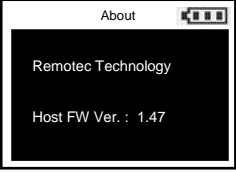
About ZRC-100

Step	Setup Key	LCD Indication
1	Press and hold ◀ ▶ keys simultaneously for 3 seconds under the Home page.	 <p style="text-align: center;">⇓</p> 
2	Select “About” and press  key. It will show the firmware version on the screen.	 <p style="text-align: center;">⇓</p> 

Z-Wave Network Setup

Rediscover Network (N.W.)

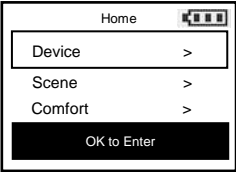
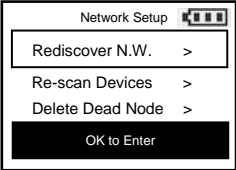
During normal operation the network decides the best path to route signals from one device to another. If devices are moved to different positions in the installation, it is recommended to rediscover the network so the routing path will be re-configured.

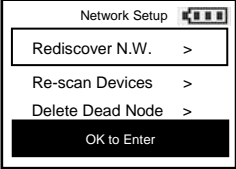
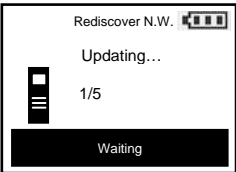
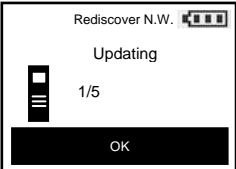
Step	Setup Key	LCD Indication
1	Press and hold ▲▼ keys simultaneously for 3 seconds under the Home page.	 <p style="text-align: center;">⇓</p> 
2	Select “Rediscover N.W.” and press  key.	
3	The remote is updating the network information. The LCD will display OK and go back to previous page when it is completed.	 <p style="text-align: center;">⇓</p> 



Re-scan (Rediscover) Devices from network



In most cases, Z-Wave gateway is the primary controller (control center), all Z-Wave devices will be added / (inclusion) by the Z-Wave gateway. Normally, it is need to click the PROG button of the Z-Wave device to add into the network and one by one. The gateway will create a control page / section to Z-Wave devices. User can control / monitor Z-Wave devices under the control page.

ZRC-100 can discover all existing Z-Wave devices from the network and no need to click the PROG button one by one, discovered devices will be re-assigned to their default categories (Devices, Comforts and Sensors), and names will be re-assigned with default naming in ascending order which is implemented by the function of “Re-scan Devices”.

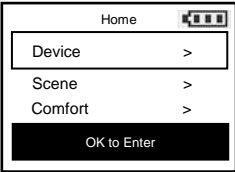
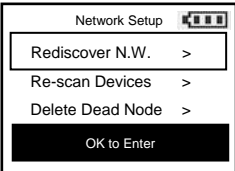

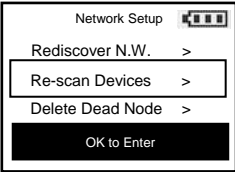
To implement this function, your ZRC-100 is needed to follow below steps:

- 1) Assume all Z-Wave devices have been added by gateway.
- 2) ZRC-100 should act as a secondary controller (receive all network and device information from a primary controller), please refer to “Learning Mode” section in this manual.
- 3) Execute the “Re-scan Devices” function with below steps.

Step	Setup Key	LCD Indication
1	Press and hold ▲▼ keys simultaneously for 3 seconds under the Home page.	 <p style="text-align: center;">↓</p> 
2	Select “Re-scan Devices” and press  key.	

3	<p>Press ► key to confirm re-scan devices or press ◀ key to cancel it and go back to previous page.</p> <p>The remote will re-scan all devices from network, discovered devices will be re-assigned to their default categories (Devices, Comforts and Sensors) names will be re-assigned in ascending order. The LCD will display OK and go back to previous page when it is completed.</p> <p>⚠</p> <p>- This action may take up to 0.5-1 hour depends on how many devices are in your network, and it will wipe out all previously stored device names!</p> <p>- Please make sure batteries are full before proceed!</p>	<div style="border: 1px solid black; padding: 5px; margin-bottom: 10px;"> <p style="text-align: right;">Re-scan Devices </p> <p>Caution! This action will wipe out all existing device names</p> <p style="text-align: center;">◀ NO Confirm? YES ▶</p> </div> <p style="text-align: center;">↓</p> <div style="border: 1px solid black; padding: 5px; margin-bottom: 10px;"> <p style="text-align: right;">Re-scan Devices </p> <p>This will take from several min to one hr! 1/5</p> <p style="text-align: center;">Waiting</p> </div> <p style="text-align: center;">↓</p> <div style="border: 1px solid black; padding: 5px;"> <p style="text-align: right;">Re-scan Devices </p> <p>This will take from several min to one hr! 1/5</p> <p style="text-align: center;">OK</p> </div>
---	--	---

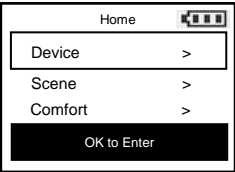
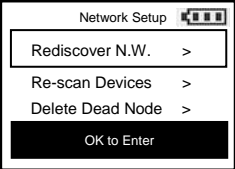
Delete Dead Node from Network

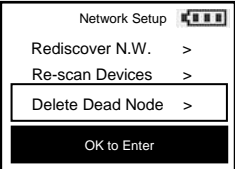
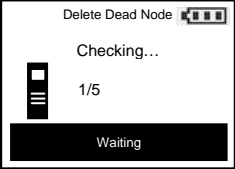
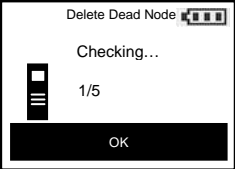
Step	Setup Key	LCD Indication
1	Press and hold ▲▼ keys simultaneously for 3 seconds under the Home page.	 <p style="text-align: center;">⇓</p> 
2	Select “Delete Dead Node” and press  key.	
3	The remote is checking the dead node. The LCD will display OK and go back to previous page when it is completed.	 <p style="text-align: center;">⇓</p> 

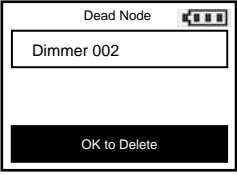
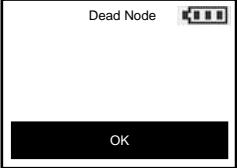
4	<p>Use ▲▼ keys to select the dead node device</p> <p>then press  key to delete it from network.</p>	 <p style="text-align: center;">⇓</p> 
---	--	--



Note 1: Only the Primary Controller can be used to include or delete devices from a network. It is recommended that you mark the primary controller for each network for ease in modifying your network.

Listening Mode

There are multiple usages by entering this mode:

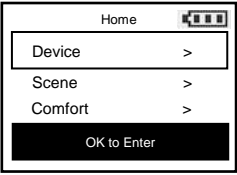
- Version command class: To get application software version, the Z-Wave protocol version and the supported Z-Wave command version of this controller.
- Manufacturer command class: To get the manufacture ID, product type ID and the product ID of this controller.
- Scene configuration command class: Home gateway can bundle a scene ID to a group ID using this command.
- Association command class: To create and maintain associations in this remote.

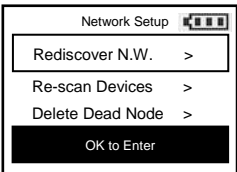
Step	Setup Key	LCD Indication
1	Place the two controllers close to each other.	-
2	Press and hold ▲▼ keys simultaneously for 3 seconds under the Home page.	 <p style="text-align: center;">⇓</p>

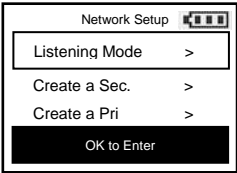
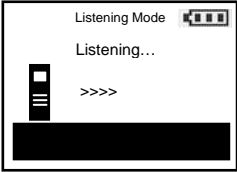
		
3	Select "Listening Mode" and press  key.	
4	The remote is entry the listening mode. (Listening mode will automatically exit after 1 minute of inactivity.)	

Note1: The mode must not be exited during communication process with another controller. Please wait for entire communication process to be completed.



Note2: It is not allowed to enter any user input from the remote's hard key after entry this Mode.

Create a Secondary Controller

(Copying Network Information to a Secondary Controller)

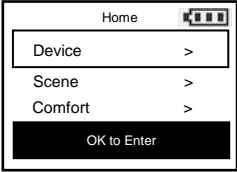
You can add a secondary controller to your network and copy all of your primary controller's network information to the secondary controller by following the steps below.

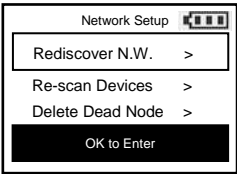

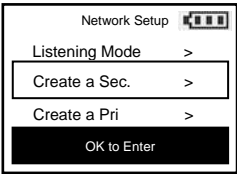
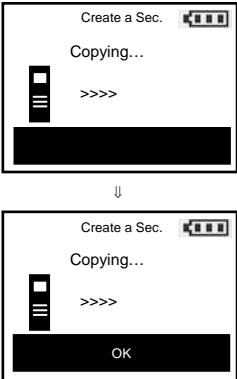
Step	Setup Key	LCD Indication
1	Place the two controllers close to each other.	-
2	Press and hold ▲▼ keys simultaneously for 3 seconds under the Home page.	

		
3	<p>Select “Create a Sec.” then press  key.</p>	
4	<p>Please make sure the target secondary controller is setup to receive information mode. (e.g. target secondary controller should enter the “Learning mode” if this is another ZRC-100. Please refer to the target controller user manual for more information)</p> <p>=> Target secondary controller will act as a <u>secondary</u> controller after this action.</p> <p>=> Original ZRC-100 primary controller will still keep in a <u>primary</u> controller after this action.</p>	

Create a Primary Controller

(Transferring Only Network Information to a New Primary Controller)

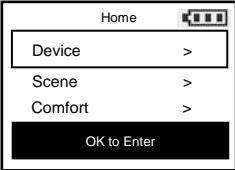
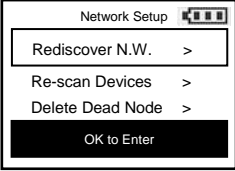
You can just transfer network information to another remote so that it will act as a new primary remote. This primary shift is done by following the steps below.

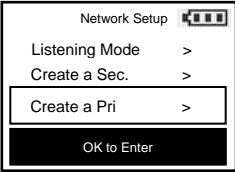
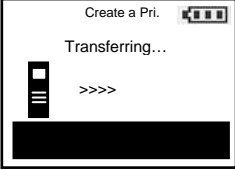
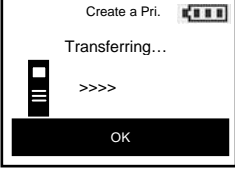
Step	Setup Key	LCD Indication
1	Place the two controllers close to each other.	-
2	Press and hold ▲▼ keys simultaneously for 3 seconds under the Home page.	 <p style="text-align: center;">⇓</p> 
3	Select “Create a Pri.” then press  key.	
4	<p>Please make sure the target primary controller is setup to receive information mode. (e.g. target primary controller should enter the “Learning mode” if this is a another ZRC-100. Please refer to the target controller user manual for more information)</p> <p>=> Target primary controller will act as a <u>primary</u> controller after this action.</p> <p>=> Original ZRC-100 primary controller will act as a <u>secondary</u> controller after this action.</p>	 <p style="text-align: center;">⇓</p> 

WIRELESS INFORMATION

Wireless range:

This device has an open air line of sight transmission distance of 100 feet which complies with the Z-Wave standards. Performance can vary depending on the amount of objects in between Z-Wave devices such as walls and furniture. Every Z-Wave device set up in your house will act as a signal repeater allowing devices to talk to each other and find alternate routes in the case of a reception dead spot.

Radio frequency limitations:

1. Each wall or object (i.e.: refrigerator, bookshelf, large TV, etc) can reduce the maximum range of 65 feet by up to 25 to 30%.
2. Plasterboard and wooden walls block less of the radio signal than concrete, brick or tile walls which will have more of an effect on signal strength.
3. Wall mounted Z-Wave devices will also suffer a loss of range as they are housed in metal junction boxes which could reduce the range by up to 25 to 30%.

MAINTENANCE

- 1 Do not expose your remote to dust, strong sunlight, humidity, high temperatures or mechanical shocks.
- 2 Do not use old and new batteries together as old batteries tend to leak.
- 3 Do not use corrosive or abrasive cleansers on your remote.
- 4 Keep the unit dust free by wiping it with a soft, dry cloth.
- 5 Do not disassemble your remote controller, it contains no user-serviceable parts.

FREQUENTLY ASKED QUESTIONS

Z-Wave Frequently Asked Questions

Q Why won't my remote work with the Z-Wave devices I purchased from another country?

A Due to different countries regulations Z-Wave products from different regions are set to different frequencies. Before purchasing new devices make sure you have checked that the device is compatible in your region.

Q Do I need an electrician to install Z-Wave products in my house?

A Installation can be simple. In some cases all you need to do is attach the Z-Wave plug in module into the wall socket. For more advanced in-wall modules you may need this done by a qualified technician.

Q What can the Remotec ZRC-100 do for me?

- A A single Z-Wave network can include 232 nodes. If necessary, more than one network can be bridged to extend the number of nodes further, although this is normally not needed in a residential environment.

The total number of controllable End-point (EP) / device / sensor is 128 items which is listed on the “Device” and “Sensor” page. ZRC-100 also supports 6 thermostats which are listed on the “Comfort” page. You can control up to 12 scenes (Scene On/Off) with your ZRC-100. Each Scene supports up to 32 Z-Wave devices or End-point (EP).

It is able to control the Z-Wave lighting devices (Dimmer or Switch) with multi-channel, window shades, thermostats, Z-Wave to AC IR extender and door lock. Also, it is support Multi-level Sensor and that can show the current room temperature on the screen.

Q If my Z-Wave devices had already added into my Z-Wave gateway (primary controller) network, what should I do for my ZRC-100? How to copy my scenes settings to my ZRC-100?

- A Your ZRC-100 can act as a secondary controller with network information about other devices and scenes setting acquired from your gateway (primary controller).

Please refer to user manual with below steps:

- i) ZRC-100 should enter the “Learning Mode” [step of B11.1] (Replicating All Network and Device Information from a Primary Controller to your ZRC-100), for details please refer to ZRC-100 user manual.
- ii) Make sure the gateway scenes were mapped to your Scene ID number and activated event for Scene Controller. You may need to setup the trigger settings on gateway before next steps.
- iii) Gateway should enter the “Inclusion Mode” to add the ZRC-100 into the network and replicating all network and device information from a primary controller to your ZRC-100, please refer to gateway user manual.
- iv) Now, ZRC-100 will act as a secondary controller. All scenes and device node information will transfer from gateway to ZRC-100, you can On/Off the scene through ZRC-100 [step of A3.1].
- v) Your ZRC-100 will acquire scene configuration and node information only. That means you have scene copied from gateway but you need to include individual Z-Wave device by ZRC-100 if you want to use ZRC-100 to control them individually.

Q Can I include all Z-Wave devices from the network by ZRC-100 and no need to click the PROG button for each device?

A Yes! ZRC-100 provides a useful function which is “Re-scan Devices” that allows rediscovering all Z-Wave devices from the network.

Please refer to user manual with below steps:

- i) Assume all Z-Wave devices have been added by gateway.
- ii) ZRC-100 should act as a secondary controller [step of B11.1].
- iii) Execute the “Re-scan Devices” function [step of C3].

ZRC-100 will rediscover Z-Wave devices from the network, discovered devices will be re-assigned to their default categories (Devices, Comforts and Sensors), and names will be re-assigned with default naming in ascending order.

! - *This action may take up to 0.5-1 hour depends on how many devices are in your network, and it will wipe out all previously stored device names!*

- Please make sure batteries are full before proceed!

- iv) Now, all Z-Wave devices will appear on the Device, Comfort and Sensor categories. You can rename your device individually if needed.

Q Can I use 2 or more ZRC-100 controllers in my house at one time?

A You can use multiple ZRC-100 around your house by assigning one remote to be the primary remote and have an additional secondary controller.

Q What is multi-channel device?

A The multi-channel command class used to control one or more end points in a given device that supports this command class.

There are several kinds of multi-channel products in the market such as Z-Wave wall switch / dimmer and power strip. It is able to control the end-point individually.

- Z-Wave wall switch / dimmer

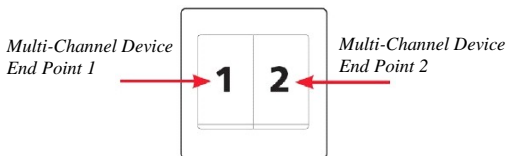

- Z-Wave power strip

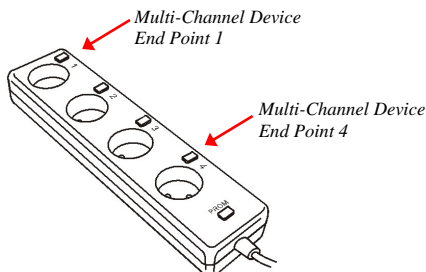

Please refer to the target device user manual for more information such as Inclusion / Exclusion and add End Point to a Scene / Group.



Some multi-channel device in the market may lack of the capability to report Multi-Channel Capability Report (MCCR) for each end point (channel).

(The MCCR is used to determine what node shall receive the association commands containing what node in the network it shall be associated to.)

In this case, the multi-channel device can only be individually controlled by ZRC-100 under Device Menu, it can not be individually assigned to different scenes, and neither can it be associated to primary sensors (e.g. door/window sensor).

There are many brands can supports multi-channel with MCCR in the market such as Merten, MK Astral, Fibaro, etc...

If you want to assign individual end-point (channel) to different scene or make individual Association with other devices, we recommend you to check with your local dealer to make sure the multi-channel device can report Multi-Channel Capability Report (MCCR) for each end point.

Q Why do I need a different module for outdoor lighting?

A The outdoor module is designed to withstand various weather conditions including heat, rain and snow.

Q If I lost my ZRC-100 will I also lose my settings?

A Yes and no, if you lose your primary ZRC-100 you will need to add all the Z-Wave devices to your new primary remote again. If you lose the secondary one you can replicate all the Z-Wave setup information from your primary remote onto a new secondary remote.

Q Where can I keep up to date with the latest Z-Wave products for my house?

A You can keep up to date by visiting the www.remotec.com.hk website where we will have information and ideas for using Z-Wave technology.

Q How do I know which product is compatible to my ZRC-100 remote?

A You can check either the specifications in the manual of your remote or also check online at www.remotec.com.hk for a full list of products that can be used with your remote. All Z-Wave products also come with the Z-Wave logo.



Q Can the ZRC-100 also operate Zigbee products?

A The ZRC-100 is not compatible with any Zigbee product.

TECHNICAL SPECIFICATIONS

Model No.	BW8380US (ZRC-100US)
Model No.	BW8380EU (ZRC-100EU)
Model No.	BW8380AU (ZRC-100AU)
Model No.	BW8380IN (ZRC-100IN)
RF Frequency	908.4MHz (US)
RF Frequency	868.4MHz (EU)
RF Frequency	921.4MHz (AU)
RF Frequency	865.2MHz (IN)
LCD	FSTN Positive Transflective 128x64 dots at A.A.= 35.8x21.7mm
LCD and key pad backlight color	Amber
Max. Range	up to 100ft outdoor line of sight, in unobstructed environment
Power	Dry cell AAA x 4pcs
Temperature	operation: 0~40°C storage: -20~60°C
Dimension (LxWxT)	161mm x 52mm x 15mm
Weight	75g (Batteries excluded)

Z-Wave device type		
Basic Device Class: BASIC_TYPE_CONTROLLER		
Generic Device Class: GENERIC_TYPE_GENERIC_CONTROLLER		
Specific Device Class: SPECIFIC_TYPE_PORTABLE_SCENE_CONTROLLER		
Z-Wave Command Class	Controlled	Supported
COMMAND_CLASS_BASIC	YES	YES
COMMAND_CLASS_SWITCH_ALL	YES	NO
COMMAND_CLASS_SWITCH_MULTILEVEL	YES	NO
COMMAND_CLASS_SCENE_ACTIVATION	YES	NO
COMMAND_CLASS_SCENE_CONTROLLER_CONF	YES	YES
COMMAND_CLASS_THERMOSTAT_MODE	YES	NO
COMMAND_CLASS_THERMOSTAT_SETPOINT	YES	NO

COMMAND_CLASS_THERMOSTAT_FAN_MODE	YES	NO
COMMAND_CLASS_SENSOR_BINARY	YES	NO
COMMAND_CLASS_SENSOR_MULTILEVEL	YES	NO
COMMAND_CLASS_CONTROLLER_REPLICATION	NO	YES
COMMAND_CLASS_ASSOCIATION	YES	YES
COMMAND_CLASS_MULTI_CHANNEL	YES	NO
COMMAND_CLASS_MULTI_CHANNEL_ASSOCIATION	YES	YES
COMMAND_CLASS_VERSION	NO	YES
COMMAND_CLASS_CONFIGURATION	YES	NO
COMMAND_CLASS_MANUFACTURER_SPECIFIC	NO	YES
COMMAND_CLASS_WAKE_UP	NO	YES
COMMAND_CLASS_DOOR_LOCK	YES	NO
COMMAND_CLASS_SECURITY	YES	YES

CHECKING THE ACCESSORIES

After opening the cover of the packing box, check that the following accessories are included.

- ZRC-100 Z-Wave Remote Controller
- ZRC-100 Quick Setup Guide
- ZRC-100 User Manual (download from our website)

FCC NOTICE

This device complies with Part 15 of the FCC rules. Operation is subject to the following two conditions:

- (1) this device may not cause harmful interference, and
- (2) this device must accept any interference received, including interference that may cause undesired operation.

WARNINGS

Changes or modifications not expressly approved by the party responsible for compliance could void the user's authority to operate the equipment.

- **RISK OF FIRE**
- **RISK OF ELECTRICAL SHOCK**
- **RISK OF BURNS**

Exercise extreme caution when using Z-Wave devices to control appliances. Operation of the Z-Wave device may be in a different room than the controlled appliances, also an unintentional activation may occur if the wrong button on the remote is pressed. Z-Wave devices may automatically be powered on due to timed event programming. Depending upon the appliance, these unattended or unintentional operations could possibly result in a hazardous condition. For these reasons we recommend the following:

- Do not include Z-Wave devices to control electric heaters or other appliances which may present a hazardous condition due to an unattended or unintentional or automatic power on control.

Do not dispose of electrical appliances as unsorted municipal waste, use separate collection facilities. Contact your local government for information regarding the collection systems available.

CAUTION

- RISK OF EXPLOSION IF BATTERY IS REPLACED BY AN INCORRECT TYPE
- DISPOSE OF USED BATTERIES ACCORDING TO THE INSTRUCTIONS

www.remotec.com.hk